

USB-C Recepticle

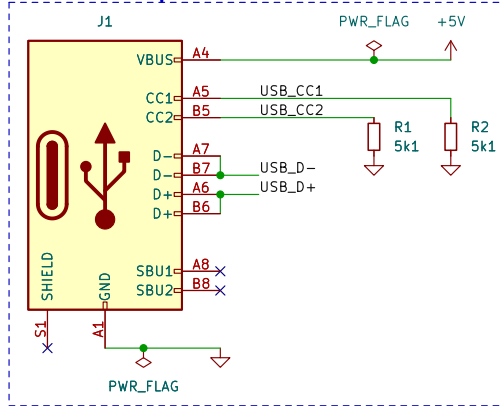

LDO

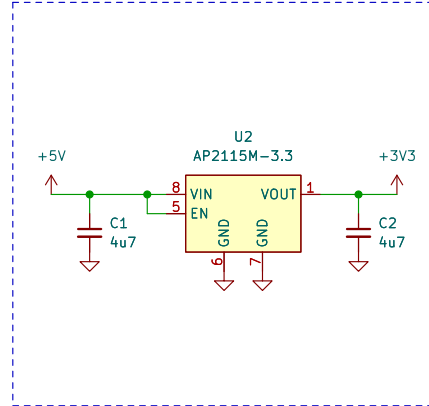

MCU

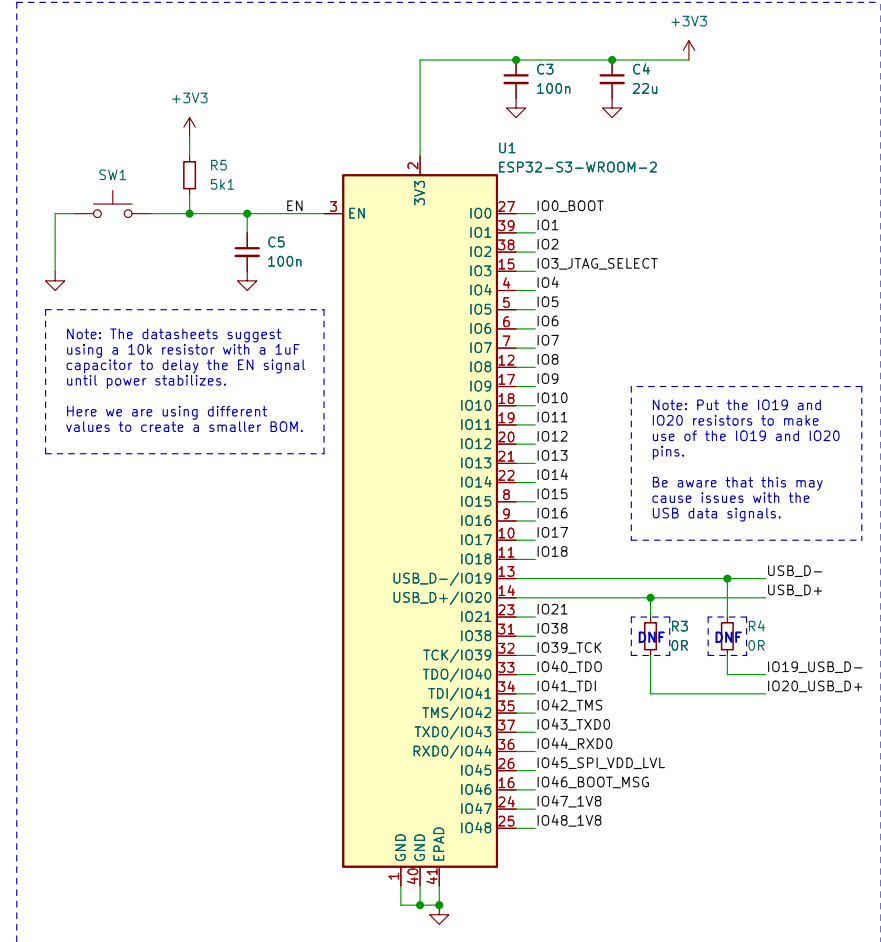

Pin Headers

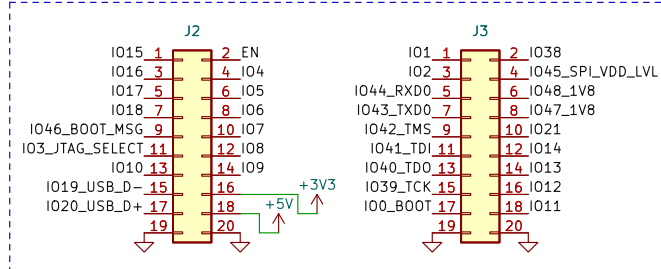

Mounting Holes

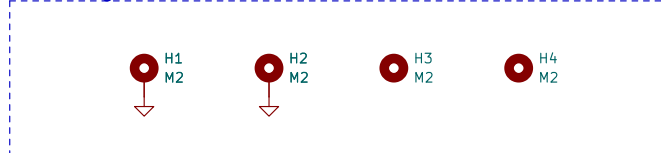

This work is licensed under a Creative Commons Attribution-ShareAlike 4.0 International License.

Martin Vladkov Sotirov <martin@libtec.org>

LibTec Inst.

Sheet: /

File: esp32_s3_wroom_2_board.kicad_sch

Title: ESP32-S3-WROOM-2 Board

Size: A4 Date: 2023-01-11

KiCad E.D.A. kicad (6.0.10)

Rev: 2

Id: 1/1